

power light source

# LUXEON® K2 Emitter

## Introduction

LUXEON® K2, the latest addition to the LUXEON high-power LED family, establishes elevated standards for light output, thermal management, and manufacturability. Offering industry-leading lumens per package and power handling capabilities, LUXEON K2 enables you to create never before possible lighting applications and:

- ♦ deliver more useable light
- ♦ optimize applications to reduce size and cost
- ♦ engineer more robust applications
- ♦ reduce thermal management engineering
- ♦ utilize standard FR4 PCB technology in addition to MCPCB solutions
- ♦ simplify manufacturing through the use of surface mount technology.

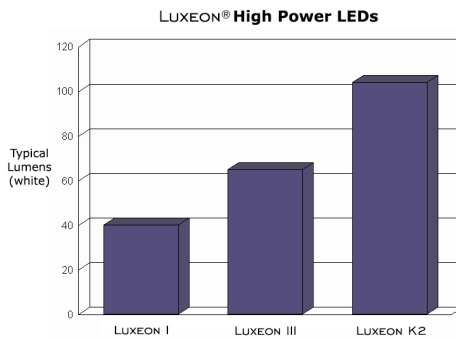

## LUXEON K2 Technology Leadership

- ♦ Highest operating junction temperature available, 185°C
- ♦ Industry leading lumen performance, > 140 lumens in 6500K white
- ♦ Highest Drive Currents—1500 mA
- ♦ Lowest Thermal Resistance—9°C/W
- ♦ Industry Best Moisture Sensitivity level—JEDEC 2a  
4 week floor life without reconditioning
- ♦ Lead free reflow solder  
JEDEC 020c compatible
- ♦ RoHS Compliant
- ♦ Autoclave compliant—JESD22 A-102
- ♦ Industry Best Lumen Maintenance—50,000 hours life at 1000 mA with 70% lumen maintenance

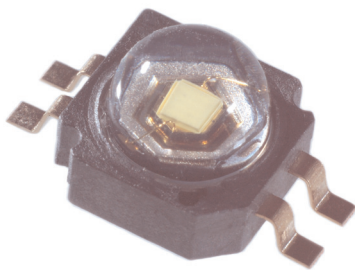

LUXEON® K2 is available in white, green, blue, royal blue, cyan, red, red-orange and amber.



---

## Table of Contents

Product Nomenclature	.3
Average Lumen Maintenance Characteristics	.3
Environmental Compliance	.3
Flux Characteristics for LUXEON K2 Junction Temperature, $T_J = 25^\circ\text{C}$	.4
Optical Characteristics	.5
Electrical Characteristics	.6
Absolute Maximum Ratings	.8
JEDEC Moisture Sensitivity	.8
Reflow Soldering Characteristics	.9
Mechanical Dimensions—SMT Lead Form	.10
Solder Pad Layout—SMT Lead Form	.11
Wavelength Characteristics	.12
Typical Light Output Characteristics over Temperature	.13
Typical Forward Current Characteristics	.14
Typical Relative Luminous Flux	.15
Current Derating Curves	.17
Typical Radiation Patterns	.21

---

## Product Nomenclature

In order to satisfy market requirements, the LUXEON K2 will be available in two configurations, one tested and binned at 350 mA and a second tested and binned at 1000 mA. Due to production distribution and variance it is difficult to accurately correlate product performance across a broad drive current range. This is one of the reasons Philips Lumileds has elected to offer multiple test current options of the LUXEON K2 to better service our customers.

The part number designation is explained as follows:

L X K 2 - A B C D - E F G

Where:

- A — designates radiation pattern (value P for Lambertian)
- B — designates color (see Philips Lumileds AB21)
- C — is a running number reserved for future products
- D — designates test current (value 2 for 350 mA, value 4 for 1000 mA)
- E — designates minimum flux bin (see Philips Lumileds AB21)
- F and G — are reserved for future product offerings

Products tested and binned at 350 mA follow the part numbering scheme:

L X K 2 - x x 1 2 - x x x

For these products typical performance is also listed for 700 mA operation.

Products tested and binned at 1000 mA follow the part numbering scheme:

L X K 2 - x x 1 4 - x x x

For these products typical performance is also listed for 1500 mA operation.

Both versions of this product are capable of operation over the entire drive current range, up to 1500 mA for white, green, cyan, blue and royal blue and up to 700 mA for red, red-orange and amber.

In addition, multiple minimum performance levels of both products are available. Digit "E" in the part-numbering scheme above, specifying the minimum performance flux bin, designates the performance option.

## Average Lumen Maintenance Characteristics

Lifetime for solid-state lighting devices (LEDs) is typically defined in terms of lumen maintenance—the percentage of initial light output remaining after a specified period of time.

Philips Lumileds projects that white LUXEON K2 products will deliver, on average, 70% lumen maintenance at 50,000 hours of operation at a forward current of 1000 mA. This projection is based on constant current operation with junction temperature maintained at or below 120°C. Philips Lumileds projects that green, blue, cyan and royal blue LUXEON K2 products will deliver, on average, 70% lumen maintenance at 50,000 hours of operation at a forward current of 1000 mA. This projection is based on constant current operation with junction temperature maintained at or below 150°C. Philips Lumileds projects that red, red-orange and amber LUXEON K2 products will deliver, on average, 70% lumen maintenance at 50,000 hours of operation at a forward current of 350 mA. This projection is based on constant current operation with junction temperature maintained at or below 120°C.

This performance is based on independent test data, Philips Lumileds historical data from tests run on similar material systems, and internal LUXEON reliability testing. Observation of design limits included in this data sheet is required in order to achieve this projected lumen maintenance.

## Environmental Compliance

Philips Lumileds is committed to providing environmentally friendly products to the solid-state lighting market. The LUXEON K2 is compliant to the European Union directives on the restriction of hazardous substances in electronic equipment, namely the RoHS directive. Philips Lumileds will not intentionally add the following restricted materials to the LUXEON K2: lead, mercury, cadmium, hexavalent chromium, polybrominated biphenyls (PBB) or polybrominated diphenyl ethers (PBDE).

## Flux Characteristics for LUXEON K2 Junction Temperature, $T_J = 25^\circ\text{C}$

Table 1.

Performance at Test Currents					Typical Performance at Indicated Current	
Color	Part Number	Minimum Luminous Flux (lm) or Radiometric Power (mW) $\Phi_V$ <sup>[1] [3]</sup>	Typical Luminous Flux (lm) or Radiometric Power (mW) $\Phi_V$ <sup>[2] [3]</sup>	Test Current (mA)	Typical Luminous Flux (lm) or Radiometric Power (mW) $\Phi_V$ <sup>[2] [3]</sup>	Drive Current (mA)
White	LXK2-PW12-R00	39.8	45	350	75	700
	LXK2-PW12-S00	51.7	60	350	100	700
	LXK2-PW14-T00	80.0	85	1000	110	1500
	LXK2-PW14-U00	87.4	100	1000	130	1500
	LXK2-PW14-V00	113.6	120	1000	140	1500
Green	LXK2-PM12-R00	39.8	45	350	75	700
	LXK2-PM12-S00	51.7	60	350	100	700
	LXK2-PM14-U00	87.4	100	1000	130	1500
Cyan	LXK2-PE12-Q00	30.6	35	350	60	700
	LXK2-PE12-R00	39.8	45	350	75	700
	LXK2-PE12-S00	51.7	60	350	100	700
	LXK2-PE14-T00	67.2	80	1000	105	1500
	LXK2-PE14-U00	87.4	100	1000	130	1500
Blue	LXK2-PB12-K00	8.2	9.5	350	16	700
	LXK2-PB12-L00	10.7	12.5	350	21	700
	LXK2-PB12-M00	13.9	16	350	27	700
	LXK2-PB14-N00	18.1	21	1000	35	1500
	LXK2-PB14-P00	23.5	27	1000	35	1500
	LXK2-PB14-Q00	30.6	35	1000	46	1500
Royal Blue	LXK2-PR12-L00	175 mW	200 mW	350	330 mW	700
	LXK2-PR12-M00	225 mW	290 mW	350	480 mW	700
	LXK2-PR14-Q00	435 mW	475 mW	1000	620 mW	1500
	LXK2-PR14-R00	515 mW	575 mW	1000	750 mW	1500
Red	LXK2-PD12-Q00	30.6	35	350	60	700
	LXK2-PD12-R00	39.8	45	350	75	700
	LXK2-PD12-S00	51.7	60	350	100	700
Red-Orange	LXK2-PH12-R00	39.8	45	350	75	700
	LXK2-PH12-S00	51.7	60	350	100	700
Amber	LXK2-PL12-P00	23.5	27	350	46	700
	LXK2-PL12-Q00	30.6	35	350	60	700
	LXK2-PL12-R00	39.8	45	350	75	700

Notes for Table 1:

1. Minimum luminous flux or radiometric power performance guaranteed within published operating conditions. Philips Lumileds maintains a tolerance of  $\pm 10\%$  on flux and power measurements.
2. Typical luminous flux or radiometric power performance when device is operated within published operating conditions.
3. LUXEON K2 products with even higher luminous flux and radiometric power levels will become available in the future. Please consult Philips Lumileds or Future Electronics for more information.

## Optical Characteristics

### Lambertian LUXEON K2 at Test Current<sup>[1]</sup> Junction Temperature, $T_J = 25^\circ\text{C}$

Table 2.

Color	Dominant Wavelength <sup>[2]</sup> $\lambda_D$ , Peak Wavelength <sup>[3]</sup> $\lambda_P$ , or Color Temperature <sup>[4]</sup> CCT			Spectral Half-width <sup>[6]</sup> (nm) $\Delta\lambda_{1/2}$	Temperature Coefficient of Dominant Wavelength (nm/ $^\circ\text{C}$ ) $\Delta\lambda_P / \Delta T_J$	Total Included Angle <sup>[7]</sup> (degrees) $\theta_{0.90V}$	Viewing Angle <sup>[8]</sup> (degrees) $2\theta_{1/2}$
	Min.	Typ.	Max.				
White <sup>[4]</sup>	4500 K	6500 K	10000 K	-	-	160	140
Green	520 nm	530 nm	550 nm	35	0.04	160	140
Cyan	490 nm	505 nm	520 nm	30	0.04	160	140
Blue	460 nm	470 nm	490 nm	25	0.04	160	140
Royal Blue <sup>[9]</sup>	440 nm	455 nm	460 nm	20	0.04	160	140
Red	620.5 nm	627 nm	645 nm	20	0.05	160	140
Red-Orange	613.5 nm	617 nm	620.5 nm	20	0.06	160	140
Amber	584.5 nm	590 nm	597 nm	14	0.09	160	140

Notes for Table 2:

1. Test current is 350 mA for all L XK2-xx12-xxx products and 1000 mA for all L XK2-xx14-xxx products.
2. Dominant wavelength is derived from the CIE 1931 Chromaticity diagram and represents the perceived color. Philips Lumileds maintains a tolerance of  $\pm 0.5$  nm for dominant wavelength measurements.
3. Royal blue product is binned by radiometric power and peak wavelength rather than photometric lumens and dominant wavelength. Philips Lumileds maintains a tolerance of  $\pm 2$  nm for peak wavelength measurements.
4. CCT  $\pm 5\%$  tester tolerance
5. CRI (Color Rendering Index) for white product types is 70.
6. Spectral width at  $1/2$  of the peak intensity.
7. Total angle at which 90% of total luminous flux is captured.
8. Viewing angle is the off axis angle from lamp centerline where the luminous intensity is  $1/2$  of the peak value.
9. All white, green, cyan, blue and royal blue products are built with Indium Gallium Nitride (InGaN).
10. All red, red-orange and amber products are built with Aluminum Indium Gallium Phosphide (AlInGaP).
11. Blue and royal blue power light sources represented here are IEC825 class 2 for eye safety.

## Electrical Characteristics

### Electrical Characteristics at 350mA for LUXEON K2, Part Numbers LXK2-xx12-xxx, Junction Temperature, $T_J = 25^\circ\text{C}$

Table 3.

Color	Forward Voltage $V_f$ <sup>[1]</sup> (V)			Typical Dynamic Resistance <sup>[2]</sup> ( $\Omega$ ) $R_D$	Typical Temperature Coefficient of Forward Voltage <sup>[3]</sup> (mV/ $^\circ\text{C}$ ) $\Delta V_f / \Delta T_J$	Typical Thermal Resistance Junction to Case ( $^\circ\text{C}/\text{W}$ ) $R_{\theta_{J-C}}$
	Min.	Typ.	Max.			
White <sup>[4]</sup>	2.79	3.42	4.23	1.0	-2.0	9
Green <sup>[4]</sup>	2.79	3.42	4.23	1.0	-2.0	9
Cyan <sup>[4]</sup>	2.79	3.42	4.23	1.0	-2.0	9
Blue <sup>[4]</sup>	2.79	3.42	4.23	1.0	-2.0	9
Royal Blue <sup>[4]</sup>	2.79	3.42	4.23	1.0	-2.0	9
Red	2.31	2.95	3.51	2.4	-2.0	12
Red-Orange	2.31	2.95	3.51	2.4	-2.0	12
Amber	2.31	2.95	3.51	2.4	-2.0	12

Notes for Table 3:

1. Philips Lumileds maintains a tolerance of  $\pm 0.06\text{V}$  on forward voltage measurements.
2. Dynamic resistance is the inverse of the slope in linear forward voltage model for LEDs. See figures 9 and 10.
3. Measured between  $25^\circ\text{C} = T_J = 110^\circ\text{C}$  at  $I_f = 350\text{ mA}$ .
4. The forward voltage of the Luxeon K2 LED will reduce by up to 0.30V at 350mA during the first few hours of operation after SMT reflow. Due to this effect, Philips Lumileds recommends current source drive for consistent and reliable performance. Cross connected series/parallel arrays or voltage drivers which could result in current hogging or variation in drive current are not recommended. Please consult your Philips Lumileds authorized distributor or Philips Lumileds Sales Representative for further information.

### Typical Electrical Characteristics at 700mA for LUXEON K2, Part Numbers LXK2-xx12-xxx, Junction Temperature, $T_J = 25^\circ\text{C}$

Table 4.

Color	Typical Forward Voltage $V_f$ <sup>[1]</sup> (V)
White	3.60
Green	3.60
Cyan	3.60
Blue	3.60
Royal Blue	3.60
Red	3.40
Red-Orange	3.40
Amber	3.40

Notes for Table 4:

1. Philips Lumileds maintains a tolerance of  $\pm 0.06\text{V}$  on forward voltage measurements.

## Electrical Characteristics at 1000mA for LUXEON K2, Part Numbers LXK2-xx14-xxx, Junction Temperature, $T_J = 25^\circ\text{C}$

Table 5.

Color	Forward Voltage $V_f$ <sup>[1]</sup>			Typical Dynamic Resistance <sup>[2]</sup> ( $\Omega$ ) $R_D$	Typical Temperature Coefficient of Forward Voltage <sup>[3]</sup> (mV/ $^\circ\text{C}$ ) $\Delta V_f / \Delta T_J$	Typical Thermal Resistance Junction to Case ( $^\circ\text{C}/\text{W}$ ) $R\theta_{J-C}$
	Min.	Typ.	Max.			
White <sup>[4]</sup>	3.03	3.72	4.95	0.6	-2.0	9
Green <sup>[4]</sup>	3.03	3.72	4.95	0.6	-2.0	9
Cyan <sup>[4]</sup>	3.03	3.72	4.95	0.6	-2.0	9
Blue <sup>[4]</sup>	3.03	3.72	4.95	0.6	-2.0	9
Royal Blue <sup>[4]</sup>	3.03	3.72	4.95	0.6	-2.0	9

Notes for Table 5:

1. Philips Lumileds maintains a tolerance of  $\pm 0.06\text{V}$  on forward voltage measurements
2. Dynamic resistance is the inverse of the slope in linear forward voltage model for LEDs. See figure 9.
3. Measured between  $25^\circ\text{C} = T_J = 110^\circ\text{C}$  at  $I_f = 1000 \text{ mA}$ .
4. The forward voltage of the Luxeon K2 LED will reduce by up to 0.50V at 1000mA during the first few hours of operation after SMT reflow. Due to this effect, Philips Lumileds recommends current source drive for consistent and reliable performance. Cross connected series/parallel arrays or voltage drivers which could result in current hogging or variation in drive current are not recommended. Please consult your Philips Lumileds authorized distributor or Philips Lumileds Sales Representative for further information.

## Typical Electrical Characteristics at 1500mA for LUXEON K2, Part Numbers LXK2-xx14-xxx, Junction Temperature, $T_J = 25^\circ\text{C}$

Table 6.

Color	Typical Forward Voltage $V_f$ <sup>[1]</sup> (V)
White	3.85
Green	3.85
Cyan	3.85
Blue	3.85
Royal Blue	3.85

Notes for Table 6:

1. Philips Lumileds maintains a tolerance of  $\pm 0.06\text{V}$  on forward voltage measurements.

## Absolute Maximum Ratings

Table 7.

Parameter	White	Green/Cyan Blue/Royal Blue	Red/Red-Orange /Amber
	Value	Value	Value
DC Forward Current (mA)	1500	1500	700
Peak Pulsed Forward Current (mA)	1500	1500	700
Average Forward Current (mA)	1500	1500	700
ESD Sensitivity	> 2,000 V HBM Class 2 JESD22-A114-B	> 2,000 V HBM Class 2 JESD22-A114-B	> 2,000 V HBM Class 2 JESD22-A114-B
LED Junction Temperature	150°C	185°C	150°C
Storage Temperature	185°C	185°C	185°C
Soldering Temperature	JEDEC 020c 260°C	JEDEC 020c 260°C	JEDEC 020c 260°C
Allowable Reflow Cycles	3	3	3
Autoclave Conditions	121°C at 2 ATM, 100% RH for 72 hours max	121°C at 2 ATM, 100% RH for 72 hours max	121°C at 2 ATM, 100% RH for 72 hours max
Reverse Voltage (Vr)	See Note 2	See Note 2	See Note 2

Notes for Table 7:

- Proper current derating must be observed to maintain junction temperature below the maximum.
- LEDs are not designed to be driven in reverse bias.
- Stresses in excess of the absolute maximum ratings can cause damage to the emitter. Maximum Rating limits apply to each parameter in isolation, all parameters having values within the Current Derating Curve. It should not be assumed that limiting values of more than one parameter can be applied to the product at the same time. Exposures to the absolute maximum ratings for extended periods can adversely affect device reliability. See Allowable Use Condition profiles below.

4.

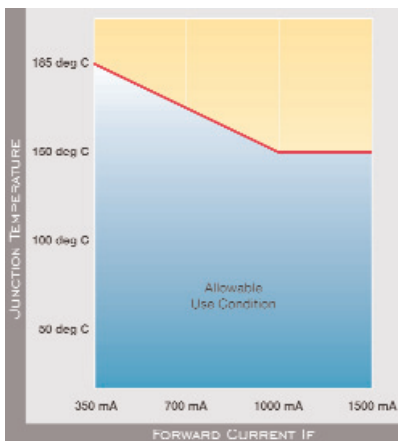

Allowable Use  
Conditions for Green,  
Cyan, Blue and  
Royal Blue.

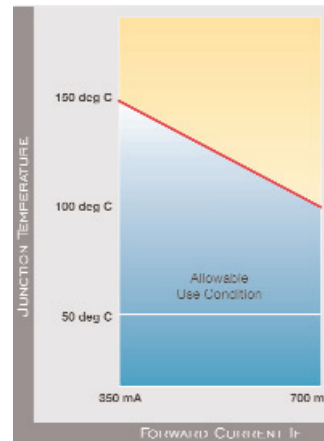

Allowable Use  
Conditions for Red,  
Red-Orange and Amber.

## JEDEC Moisture Sensitivity

Table 8.

Level	Soak Requirements					
	Floor Life		Standard		Accelerated Environment	
	Time	Conditions	Time (hours)	Conditions	Time (hours)	Conditions
2a	4 weeks	≤ 30°C / 60% RH	696 <sup>[1]</sup> + 5/-0	30°C / 60% RH	120 +1/-0	60°C / 60% RH

Notes for Table 8:

- The standard soak time includes a default value of 24 hours for semiconductor manufacturer's exposure time (MET) between bake and bag and includes the maximum time allowed out of the bag at the distributor's facility.



## Reflow Soldering Characteristics

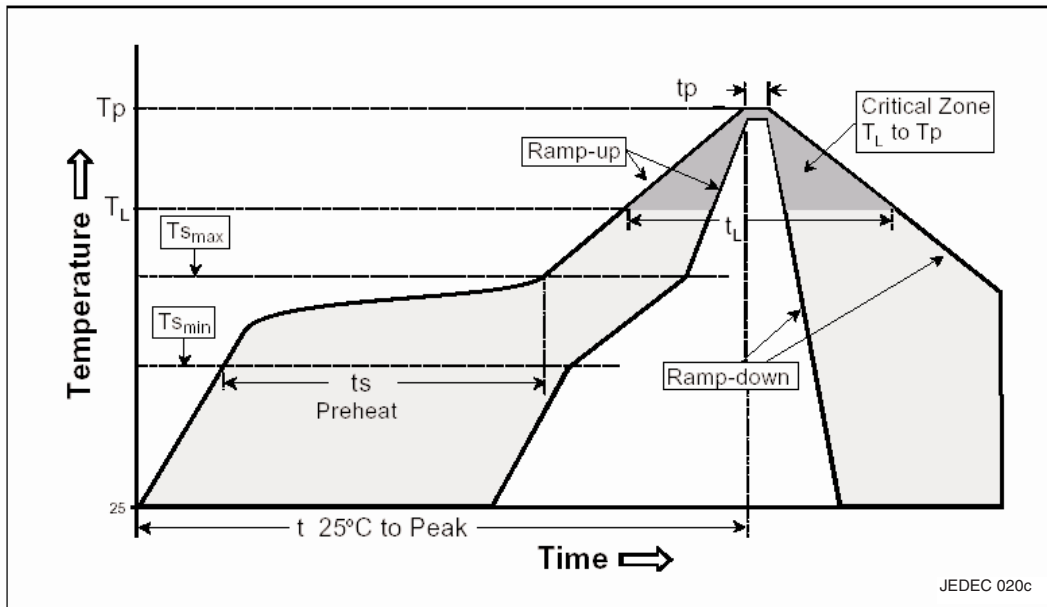

Table 9.

Profile Feature	Lead Free Assembly
Average Ramp-Up Rate ( $T_{s_{max}}$ to $T_p$ )	3°C / second max
Preheat Temperature Min ( $T_{s_{min}}$ )	150°C
Preheat Temperature Max ( $T_{s_{max}}$ )	200°C
Preheat Time ( $t_{s_{min}}$ to $t_{s_{max}}$ )	60 - 180 seconds
Temperature ( $T_L$ )	217°C
Time Maintained Above Temperature ( $T_L$ )	60 - 150 seconds
Peak / Classification Temperature ( $T_p$ )	260°C
Time Within 5°C of Actual Peak Temperature ( $T_p$ )	20 - 40 seconds
Ramp - Down Rate	6°C / second max
Time 25°C to Peak Temperature	8 minutes max

Notes for Table 9:

1. All temperatures refer to topside of the package, measured on the package body surface.

## Mechanical Dimensions - SMT Lead Form

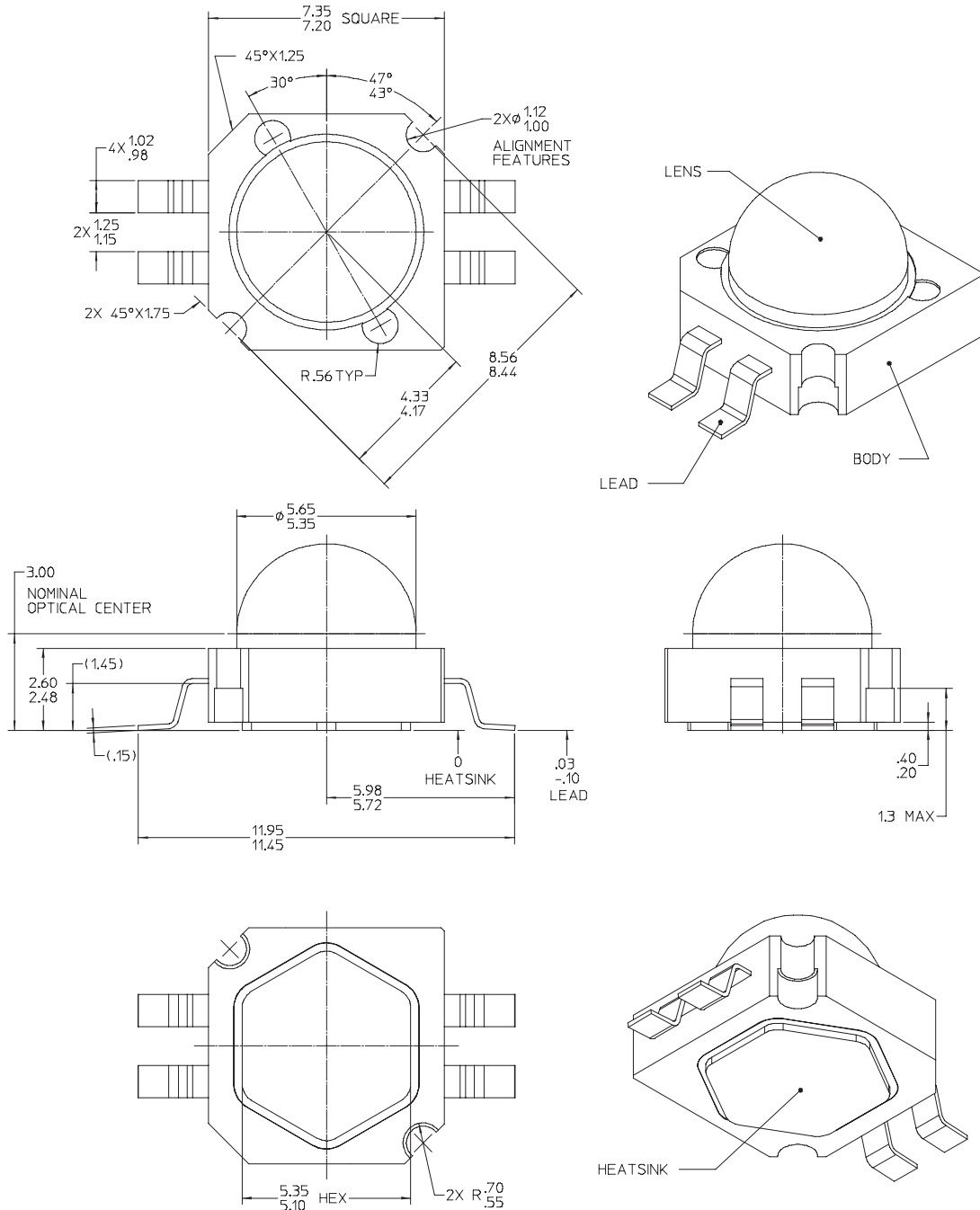

Figure 1. 4-lead Gullwing Package Outline Drawing.

Notes for Figure 1:

1. The anode side of the device is denoted by the chamfer on the part body. Electrical insulation between the case and the board is required—slug of the device is not electrically neutral. Do not electrically connect either the anode or cathode to the slug.
2. Do not handle the device by the lens—care must be taken to avoid damage to the lens or the interior of the device that can be damaged by excessive force to the lens.
3. Drawings not to scale.
4. All dimensions are in millimeters.
5. All dimensions without tolerances are for reference only.
6. Recommended solder paste thickness of 0.15mm.

## Solder Pad Design—SMT Lead Form

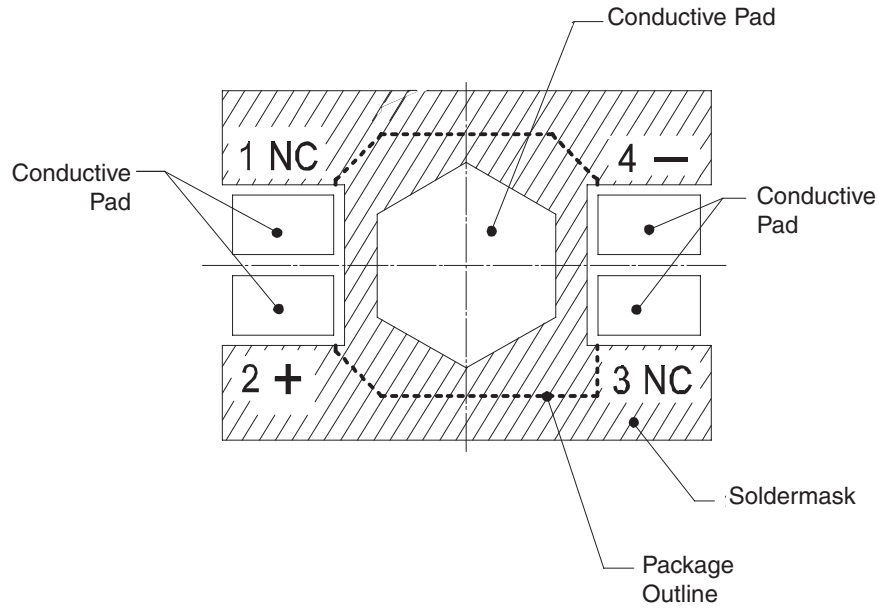

Figure 2. 4-lead Gullwing Solder Pad Design.

Notes for Figure 2:

1. Electrical isolation is required between signal leads and hexagonal heat slug contact.
2. For optimal thermal performance, maximize board metallization at hexagonal heat slug contact.

## Solder Pad Layout—SMT Lead Form

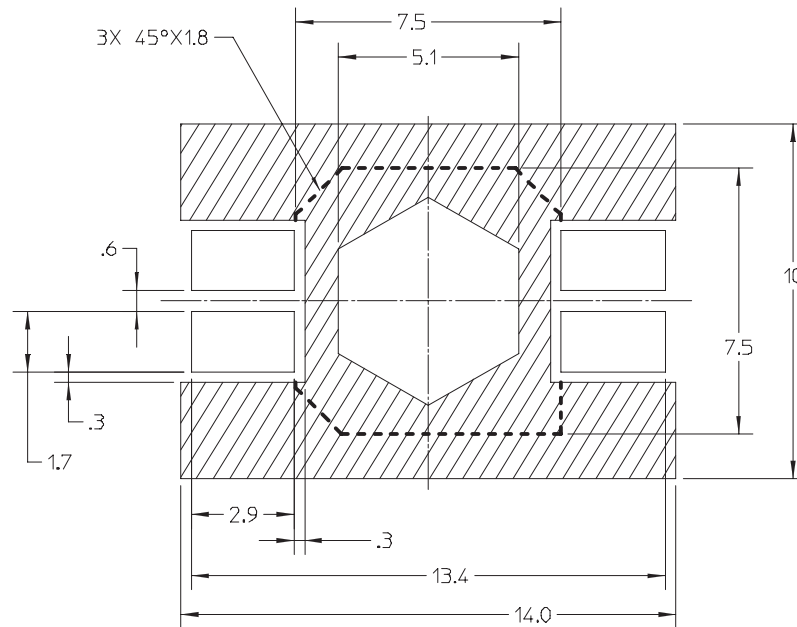

Figure 3. 4-lead Gullwing Package Solder Pad Layout.

## Pin Out Diagram

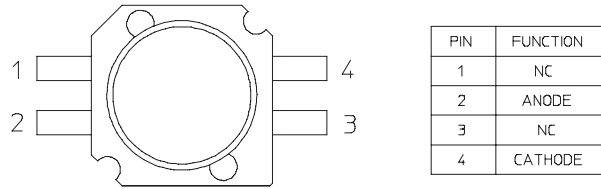

Figure 4. 4-lead Gullwing Pin Out Diagram.

## Wavelength Characteristics

### Green, Cyan, Blue, Royal Blue, Red, Red-Orange and Amber at Test Current Junction Temperature, $T_J = 25^\circ\text{C}$

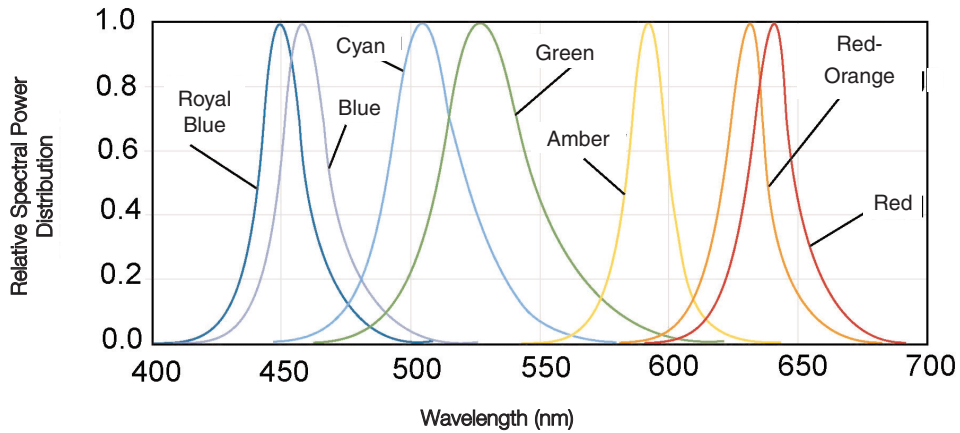

Figure 5. Relative intensity vs. wavelength.

### White at Test Current Junction Temperature, $T_J = 25^\circ\text{C}$

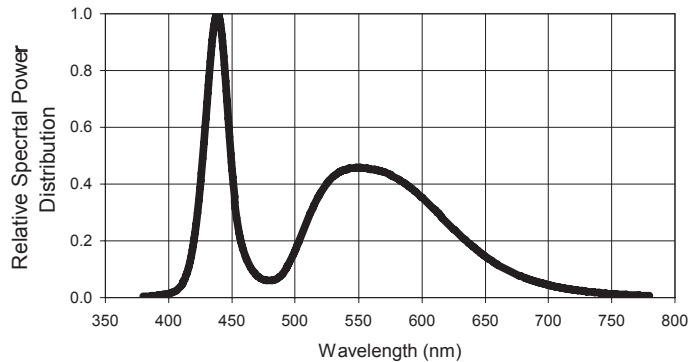

Figure 6. White color spectrum of typical CCT part, integrated measurement.

## Typical Light Output Characteristics over Temperature

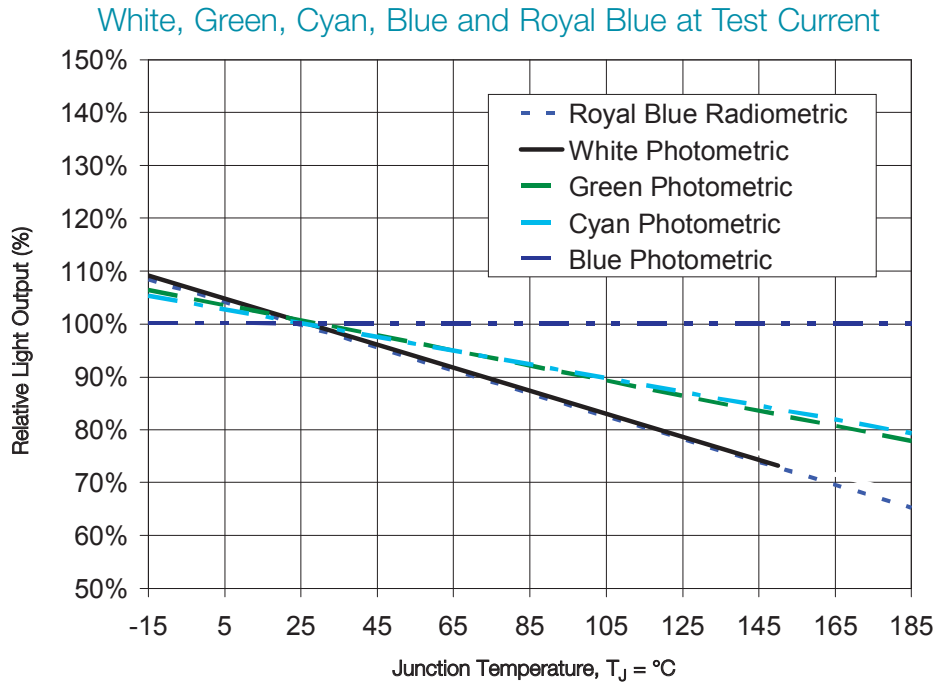

Figure 7. Relative light output vs. junction temperature for white, green, cyan, blue and royal blue.

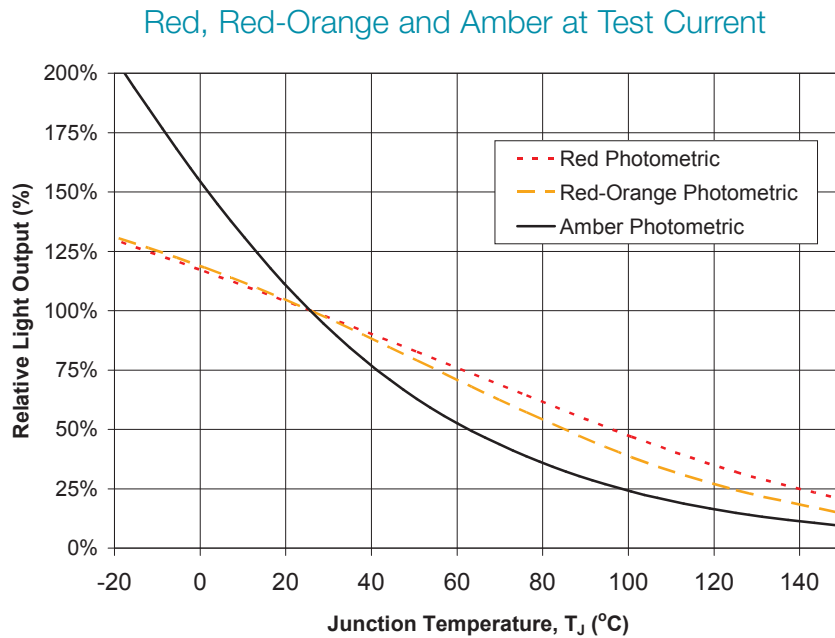

Figure 8. Relative light output vs. junction temperature for red, red-orange and amber.

## Typical Forward Current Characteristics

White, Green, Cyan, Blue and Royal Blue, Junction Temperature,  $T_J = 25^\circ\text{C}$

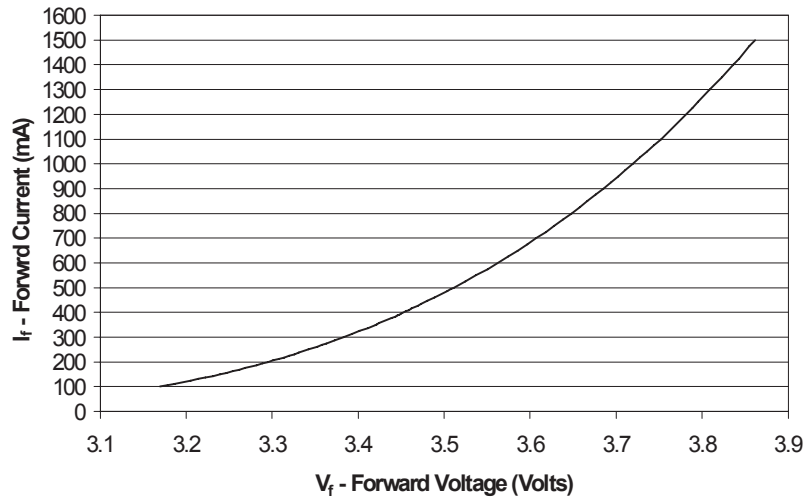

Figure 9. Forward current vs. forward voltage for white, green, cyan, blue and royal blue.

Red, Red-Orange and Amber, Junction Temperature,  $T_J = 25^\circ\text{C}$

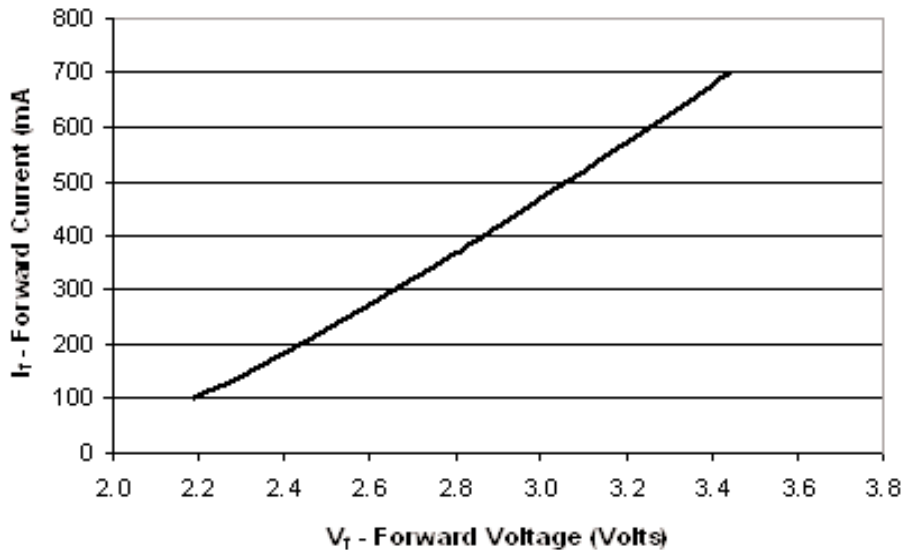

Figure 10. Forward current vs. forward voltage for red, red-orange and amber.

Notes for Figures 9 & 10:

Driving these high power devices at currents less than the test conditions (350 mA or 1000 mA) may produce unpredictable results and may be subject to variation in performance. Pulse width modulation (PWM) is recommended for dimming effects.

## Typical Relative Luminous Flux

### Relative Luminous Flux vs. Forward Current for White, Green, Cyan, Blue and Royal Blue Junction Temperature, $T_J = 25^\circ\text{C}$

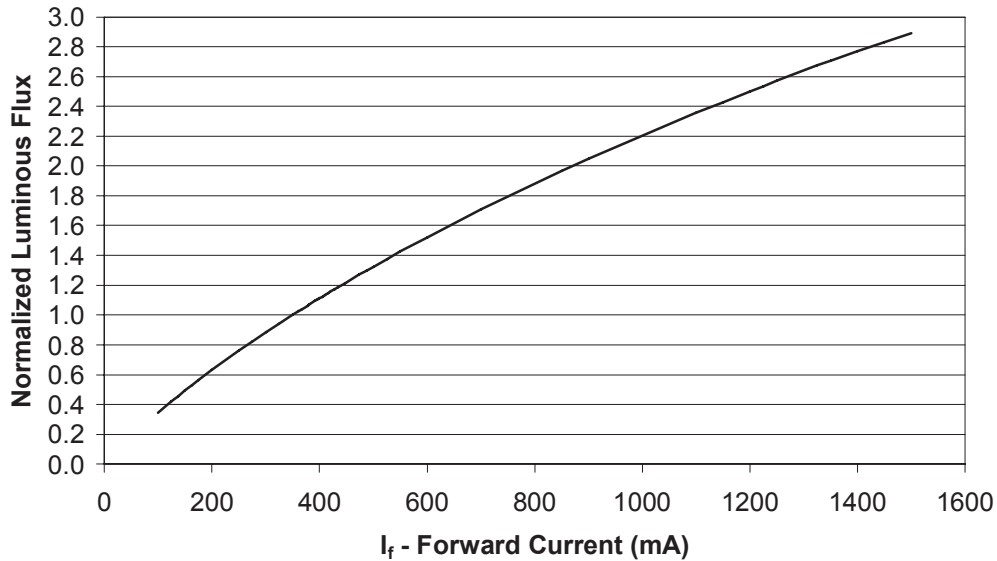

Figure 11. Relative luminous flux or radiometric power vs. forward current for white, green, cyan, blue and royal blue at  $T_J = 25^\circ\text{C}$  maintained, test current 350 mA.

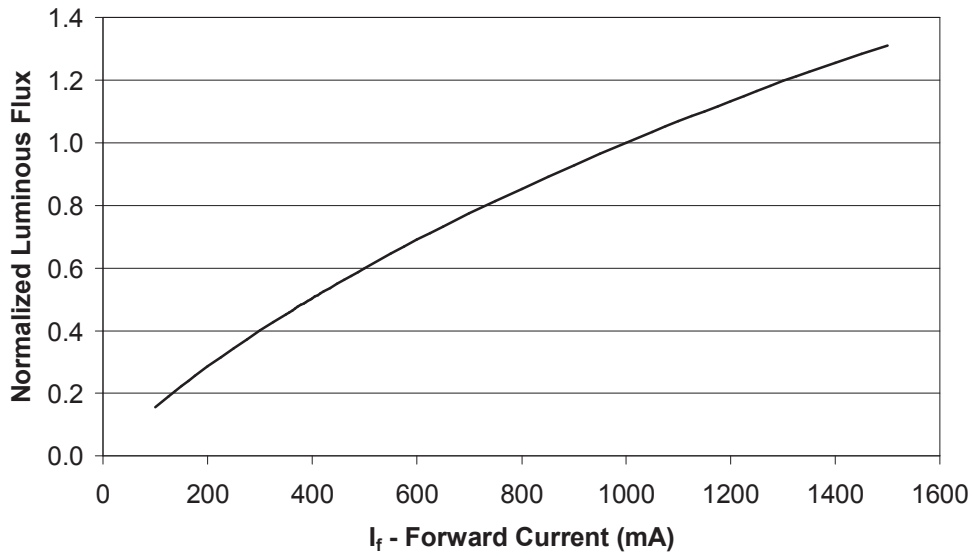

Figure 12. Relative luminous flux or radiometric power vs. forward current for white, green, cyan, blue and royal blue at  $T_J = 25^\circ\text{C}$  maintained, test current 1000 mA.

Notes for Figures 11 & 12:

Driving these high power devices at currents less than the test conditions (350 mA or 1000 mA) may produce unpredictable results and may be subject to variation in performance. Pulse width modulation (PWM) is recommended for dimming effects.

## Relative Luminous Flux vs. Forward Current for Red, Red-Orange and Amber, Junction Temperature, $T_J = 25^\circ\text{C}$

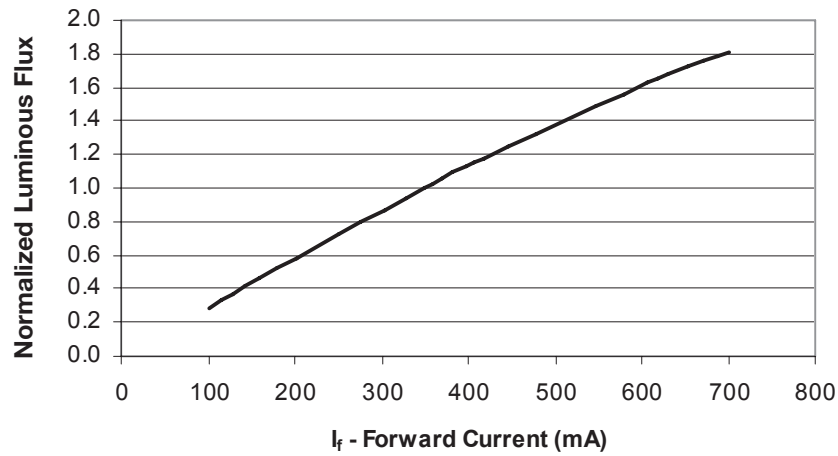

Figure 13: Relative luminous flux or radiometric power vs. forward current for red, red-orange and amber at  $T_J = 25^\circ\text{C}$  maintained, test current 350 mA.

Note for Figure 13:

Driving these high power devices at currents less than the test conditions (350 mA or 1000 mA) may produce unpredictable results and may be subject to variation in performance. Pulse width modulation (PWM) is recommended for dimming effects.



## Current Derating Curves

### Current Derating Curve for 350 mA Drive Current White

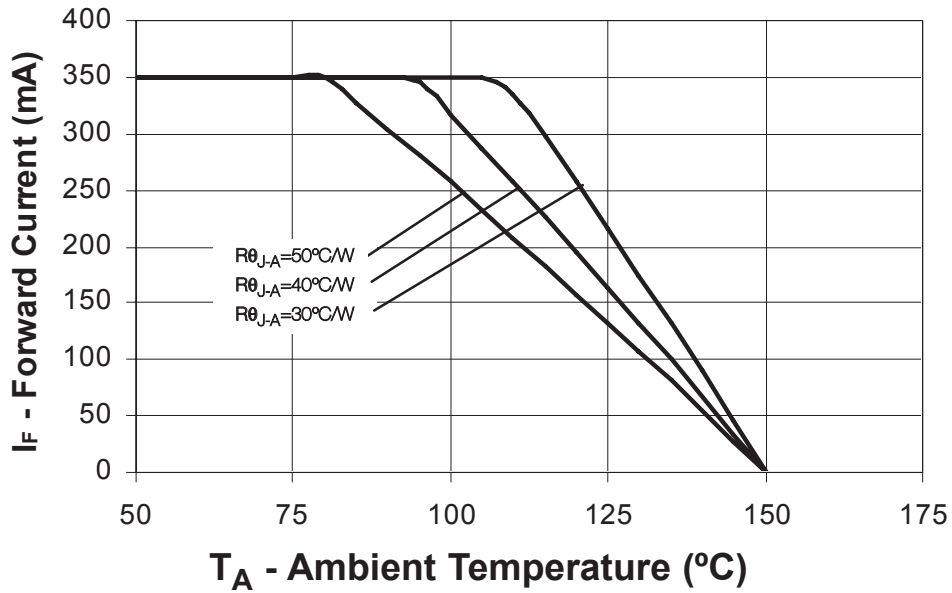

Figure 14: Maximum forward current vs. ambient temperature, based on  $T_{JMAX} = 150^\circ\text{C}$ .

### Current Derating Curve for 350 mA Drive Current Green, Cyan, Blue and Royal Blue

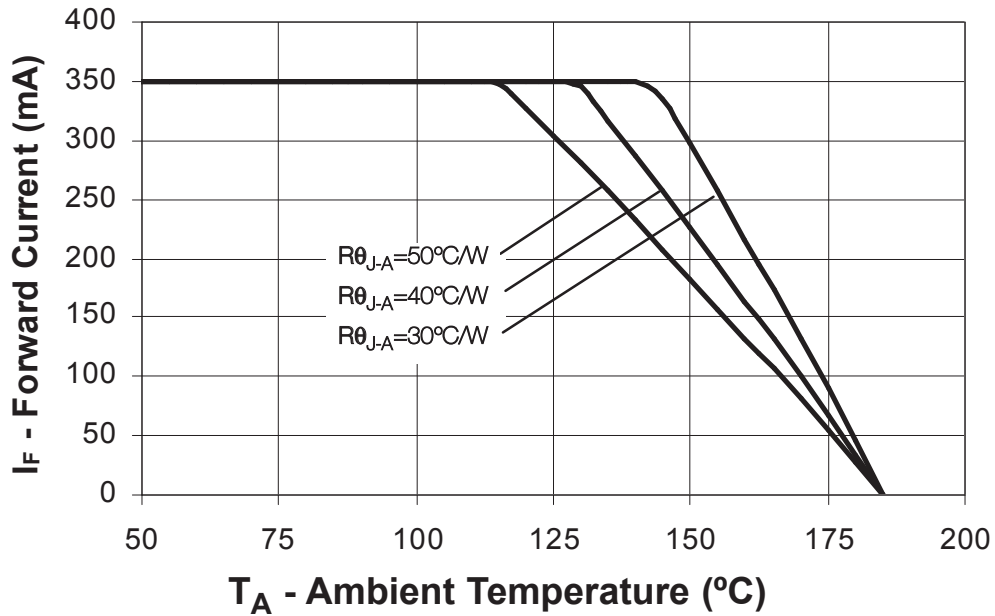

Figure 15: Maximum forward current vs. ambient temperature, based on  $T_{JMAX} = 185^\circ\text{C}$ .

## Current Derating Curve for 350 mA Drive Current Red, Red-Orange and Amber

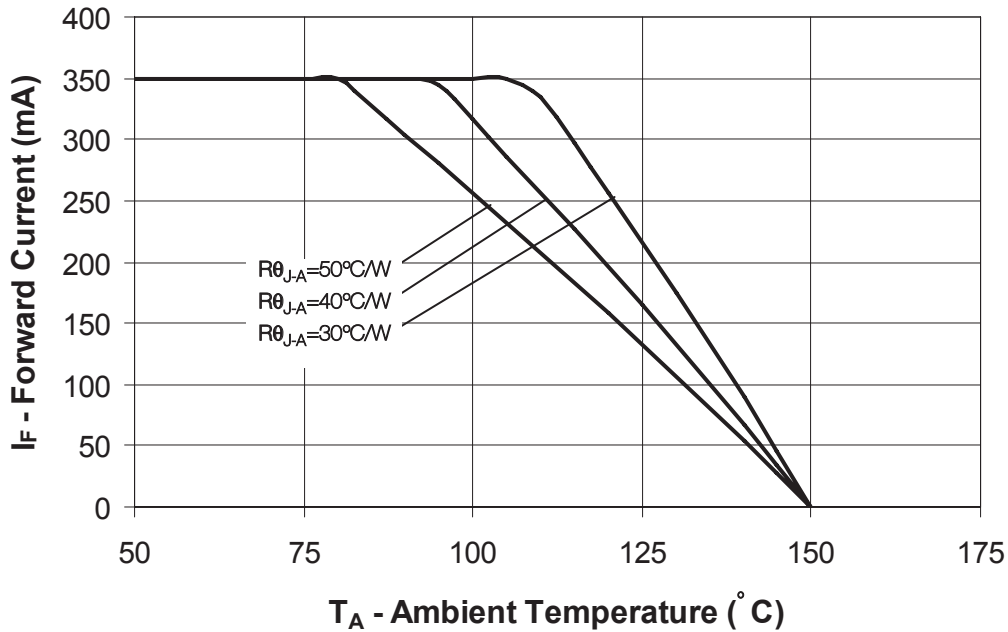

Figure 16: Maximum forward current vs. ambient temperature, based on  $T_{JMAX} = 150^{\circ}\text{C}$ .

## Current Derating Curve for 700 mA Drive Current White

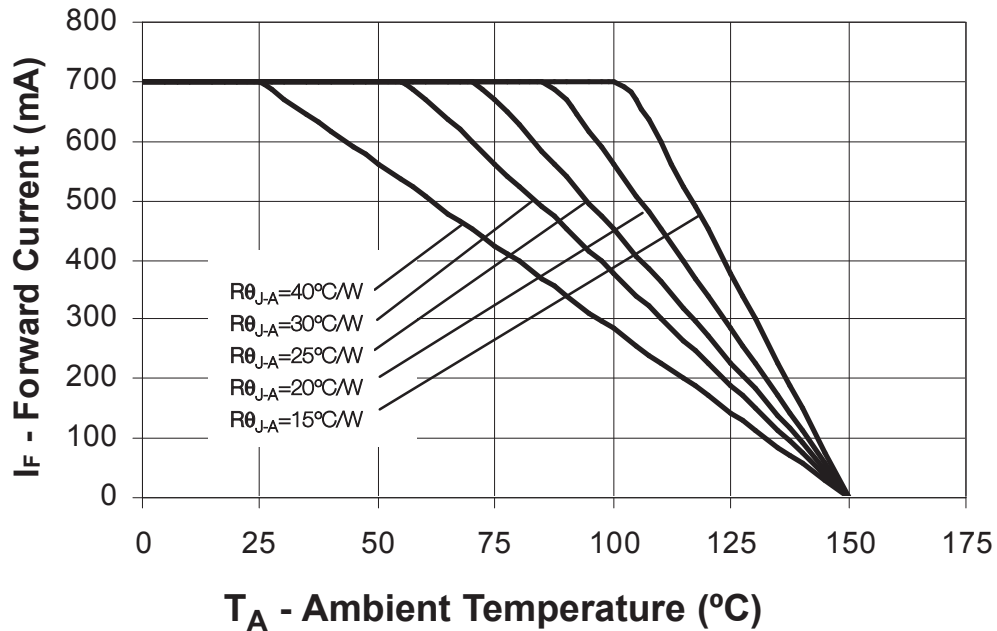

Figure 17: Maximum forward current vs. ambient temperature, based on  $T_{JMAX} = 150^{\circ}\text{C}$ .

## Current Derating Curve for 700 mA Drive Current Green, Cyan, Blue and Royal Blue

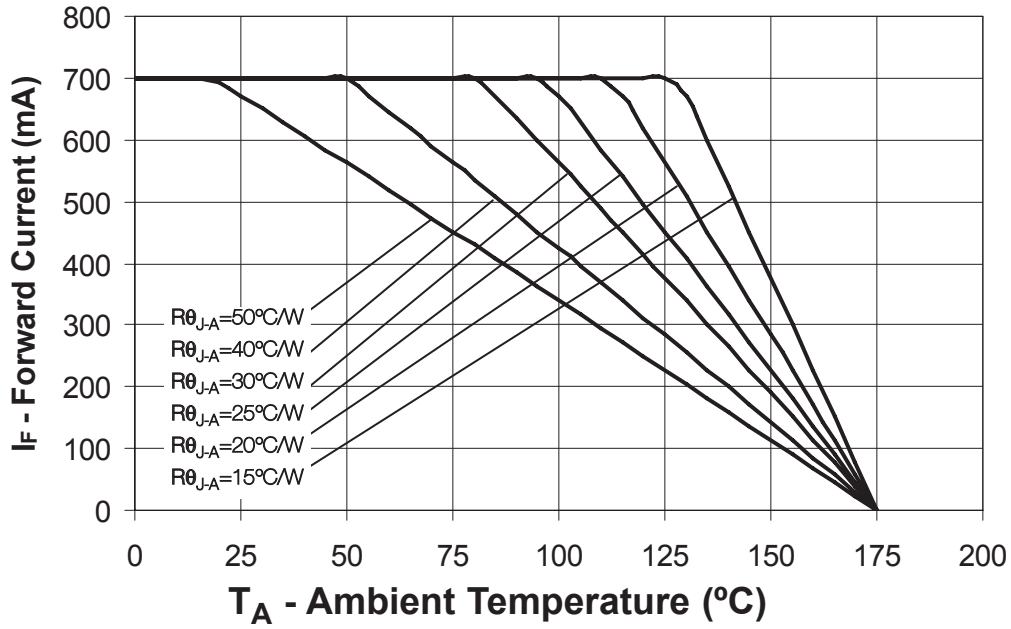

Figure 18: Maximum forward current vs. ambient temperature, based on  $T_{JMAX} = 175^{\circ}\text{C}$ .

## Current Derating Curve for 700 mA Drive Current Red, Red-Orange and Amber

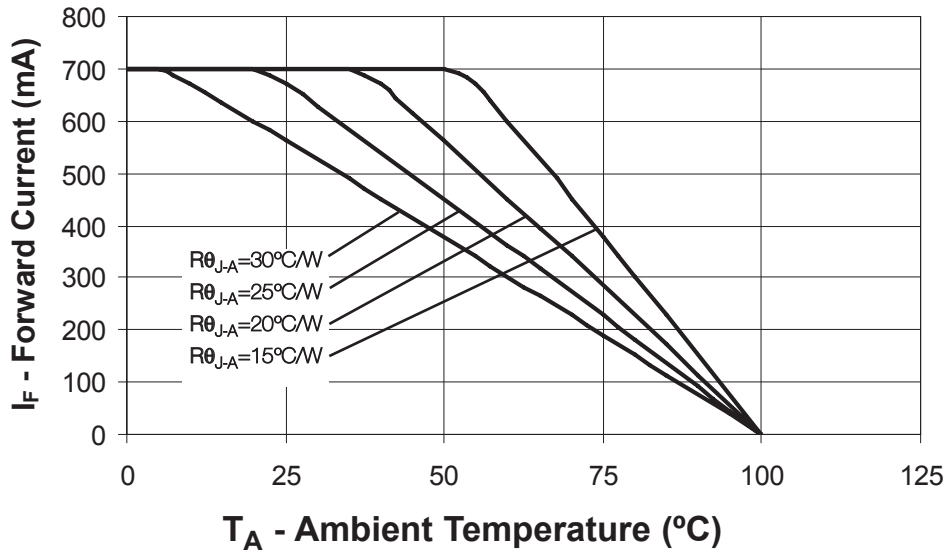

Figure 19: Maximum forward current vs. ambient temperature, based on  $T_{JMAX} = 100^{\circ}\text{C}$ .

## Current Derating Curve for 1000 mA Drive Current White, Green, Cyan, Blue and Royal Blue

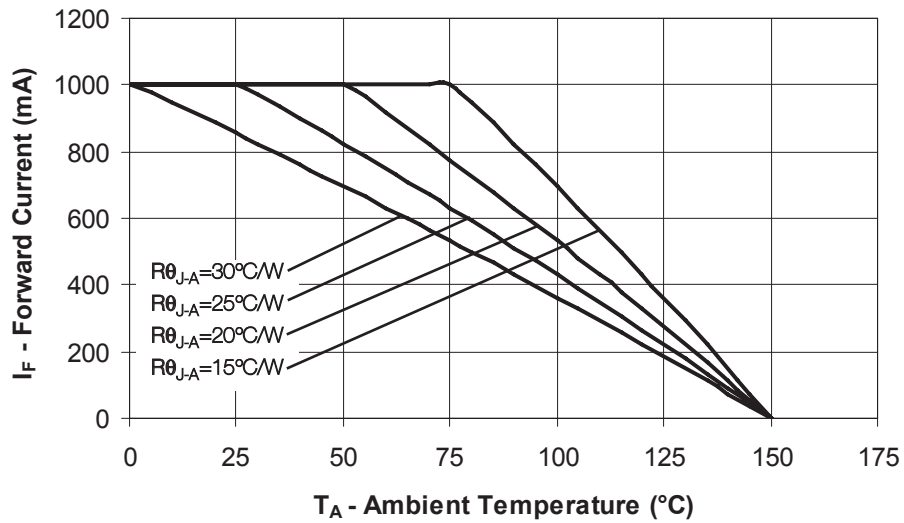

Figure 20: Maximum forward current vs. ambient temperature, based on  $T_{JMAX} = 150^{\circ}C$ .

## Current Derating Curve for 1500 mA Drive Current White, Green, Cyan, Blue and Royal Blue

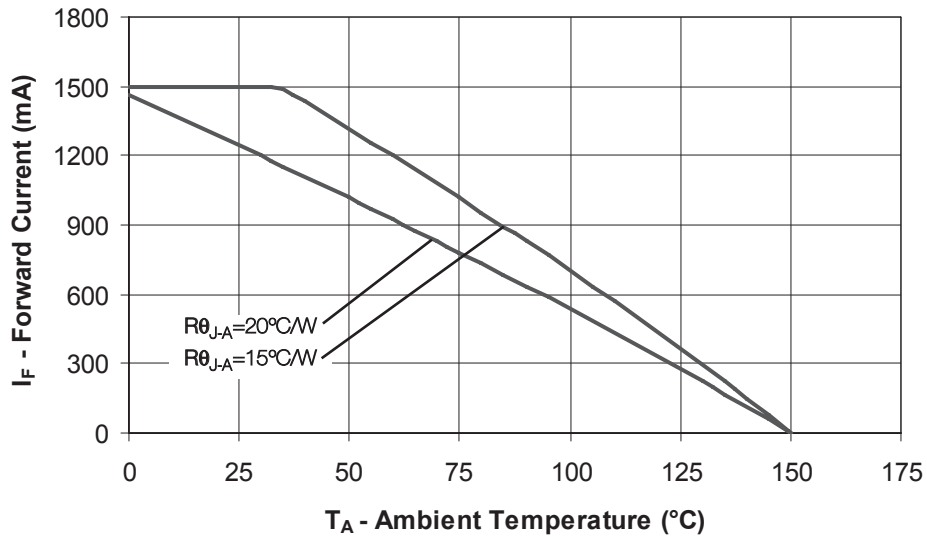

Figure 21: Maximum forward current vs. ambient temperature, based on  $T_{JMAX} = 150^{\circ}C$ .

## Typical Radiation Patterns

### Typical Representative Spatial Radiation Pattern for White Lambertian

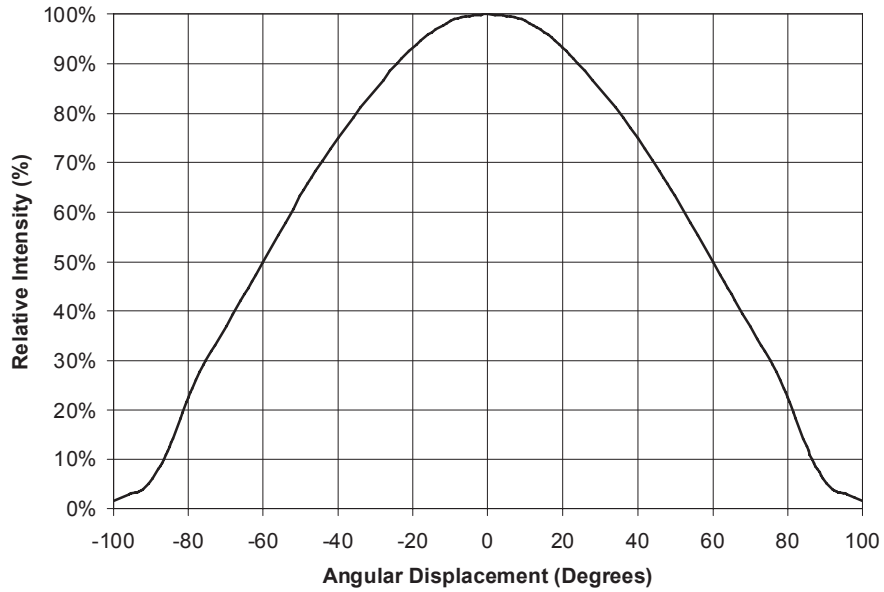

Figure 22: Typical Representative Spatial Radiation Pattern for White Lambertian.

### Typical Polar Radiation Pattern for White Lambertian

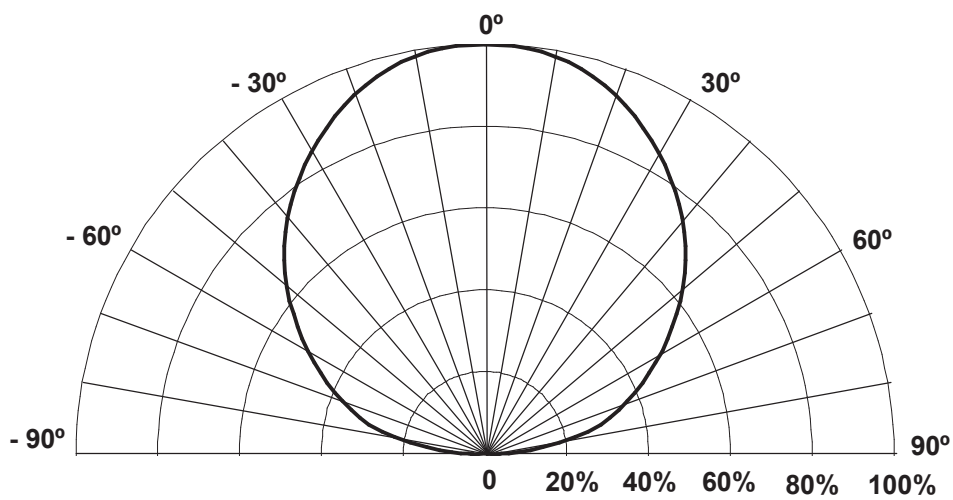

Figure 23: Typical Polar Radiation Pattern for White Lambertian.

## Typical Representative Spatial Radiation Pattern for Green, Cyan, Blue and Royal Blue Lambertian

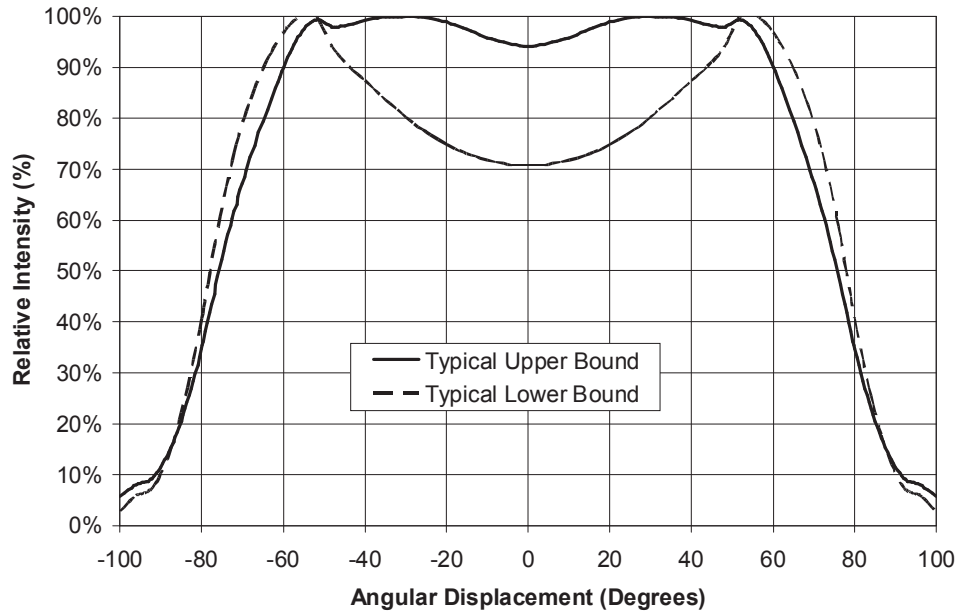

Figure 24: Typical Representative Spatial Radiation Pattern for Green, Cyan, Blue and Royal Blue Lambertian.

## Typical Polar Radiation Pattern for Green, Cyan, Blue and Royal Blue Lambertian

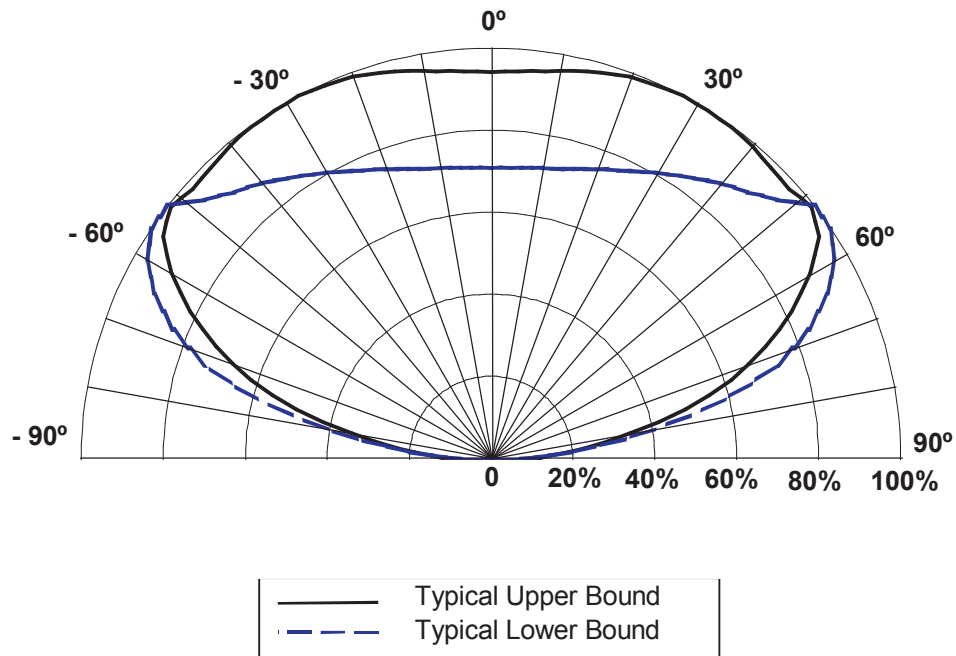

Figure 25: Typical Polar Radiation Pattern for Green, Cyan, Blue and Royal Blue Lambertian.

## Typical Representative Spatial Radiation Pattern for Red, Red-Orange and Amber Lambertian

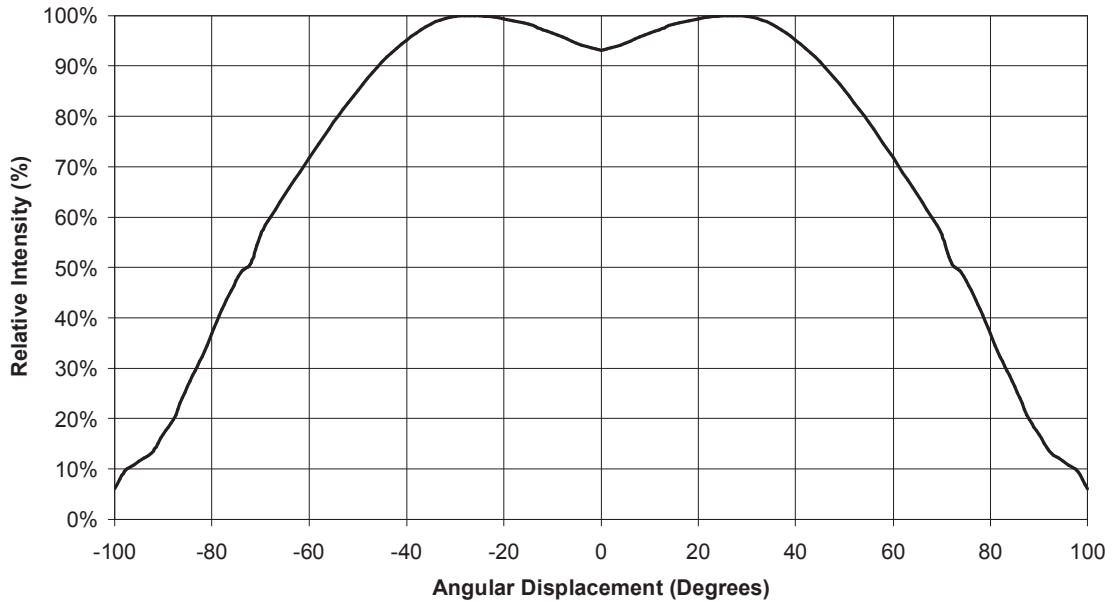

Figure 26: Typical Representative Spatial Radiation Pattern for Red, Red\_Orange and Amber Lambertian.

## Typical Polar Radiation Pattern for Red, Red-Orange and Amber Lambertian

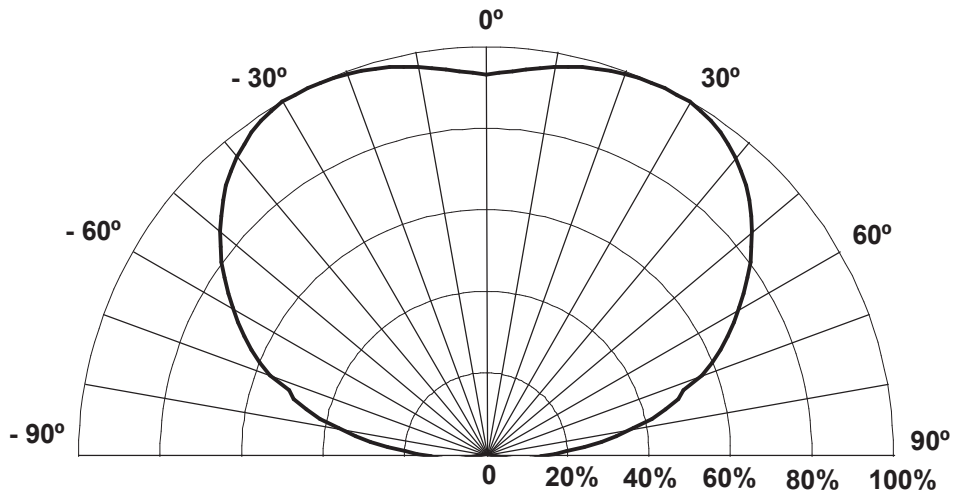
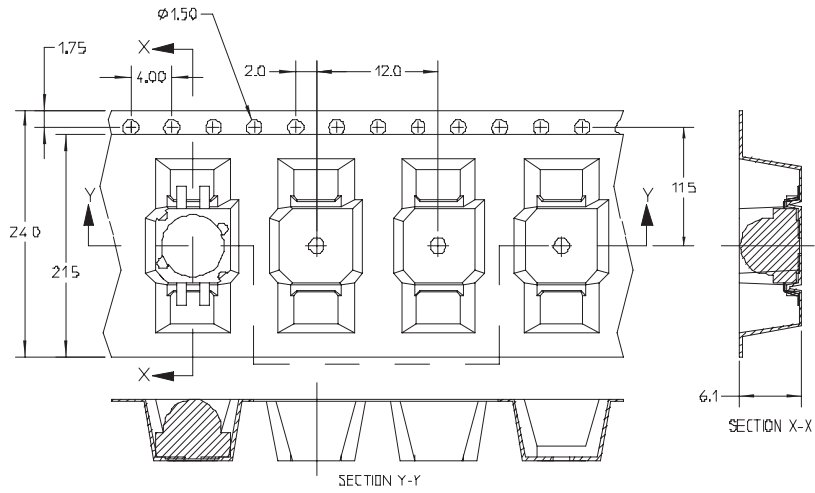
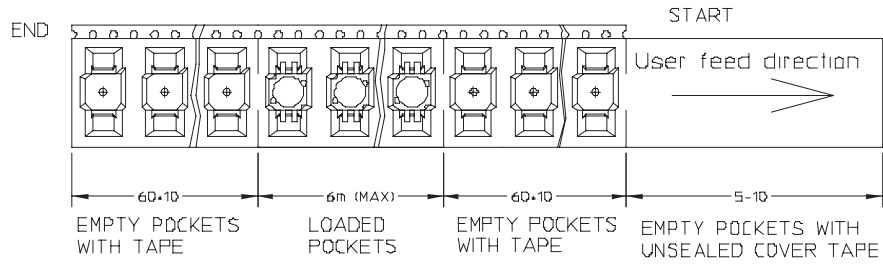
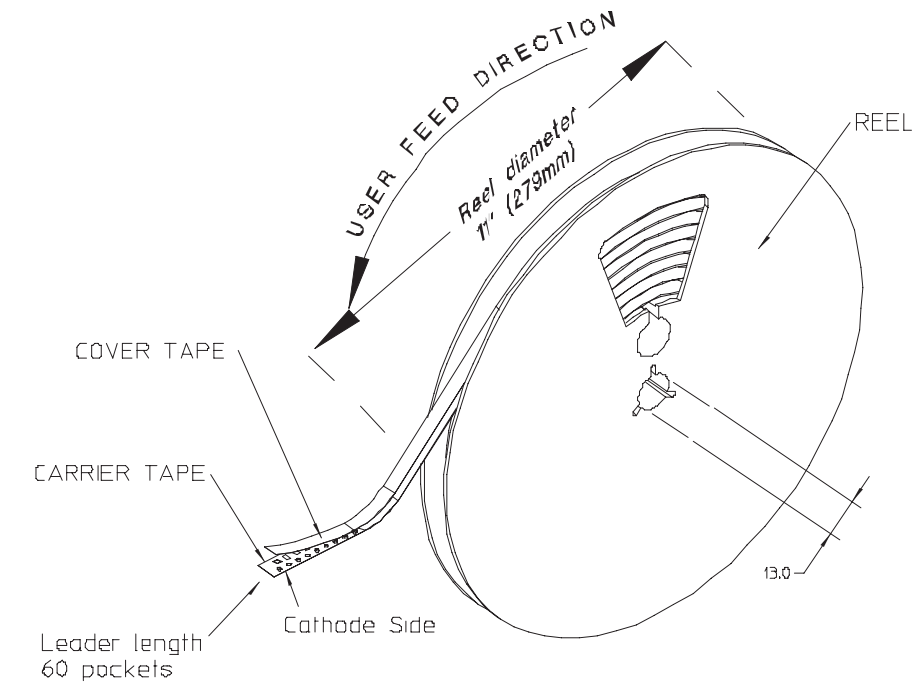

Figure 27: Typical Polar Radiation Pattern for Red, Red-Orange and Amber Lambertian.

# Emitter Reel Packaging







### Company Information

LUXEON® is developed, manufactured and marketed by Philips Lumileds Lighting Company. Philips Lumileds is a world-class supplier of Light Emitting Diodes (LEDs) producing billions of LEDs annually. Philips Lumileds is a fully integrated supplier, producing core LED material in all three base colors (Red, Green, Blue) and White. Philips Lumileds has R&D centers in San Jose, California and in The Netherlands and production capabilities in San Jose and Penang, Malaysia. Founded in 1999, Philips Lumileds is the high-flux LED technology leader and is dedicated to bridging the gap between solid-state LED technology and the lighting world. Philips Lumileds technology, LEDs and systems are enabling new applications and markets in the lighting world.

Philips Lumileds may make process or materials changes affecting the performance or other characteristics of our products. These products supplied after such changes will continue to meet published specifications, but may not be identical to products supplied as samples or under prior orders.



[WWW.LUXEON.COM](http://WWW.LUXEON.COM)  
[WWW.LUMILEDSFUTURE.COM](http://WWW.LUMILEDSFUTURE.COM)

FOR TECHNICAL ASSISTANCE OR THE LOCATION OF YOUR NEAREST SALES OFFICE CONTACT ANY OF THE FOLLOWING:

**NORTH AMERICA:**  
+1 888 589 3662 OR  
[ASKLUXEON@FUTUREELECTRONICS.COM](mailto:ASKLUXEON@FUTUREELECTRONICS.COM)

**EUROPE:**  
OO 800 443 88 873 OR  
[LUXEON.EUROPE@FUTUREELECTRONICS.COM](mailto:LUXEON.EUROPE@FUTUREELECTRONICS.COM)

**ASIA:**  
800 5864 5337 OR  
[LUMILEDS.ASIA@FUTUREELECTRONICS.COM](mailto:LUMILEDS.ASIA@FUTUREELECTRONICS.COM)